

D-SUB IDC TYPE

SPECIFICATION

Current Rate:5AMP
 Insulation Resistance:1000MΩ Min
 Contact Resistance:20mΩ Max
 Dielectric voltage:1000V AC for one minute
 Operation Temperature:-55°C to + 105°C

MATERIAL

Insulator:Polyester,UL 94V-0
 ◎ Standard:P.B.T
 Contact Pin F:Phosphor Bronze
 M:Brass
 Shell -Steel zinc plated or
 tin plated or nickel plated
 Screw-Brass nickel plated

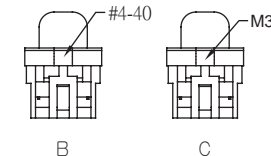
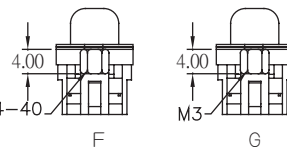
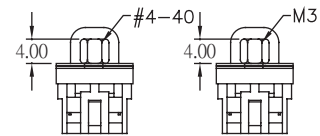
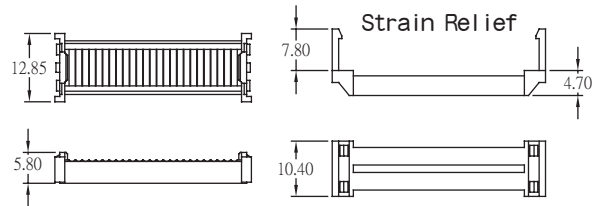
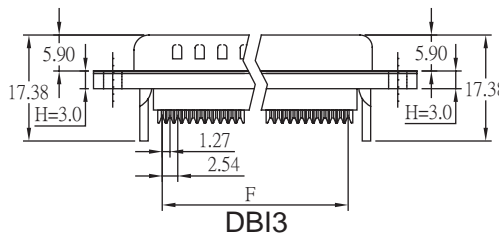
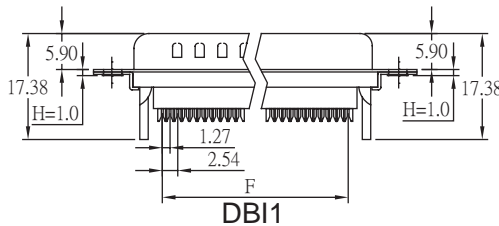
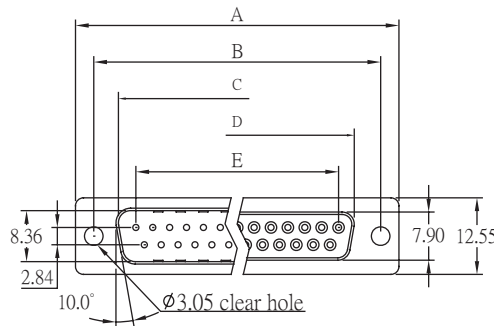
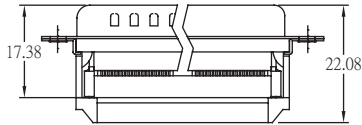

Dimensions

Positions	A	B	C	D	E	F
9	30.81	24.99	16.92	16.33	11.08	10.16
15	39.14	33.32	25.50	24.66	19.39	17.78
25	53.04	47.04	38.96	38.38	33.24	30.48
37	69.32	63.50	55.42	54.84	49.86	45.72

ORDER INFORMATION

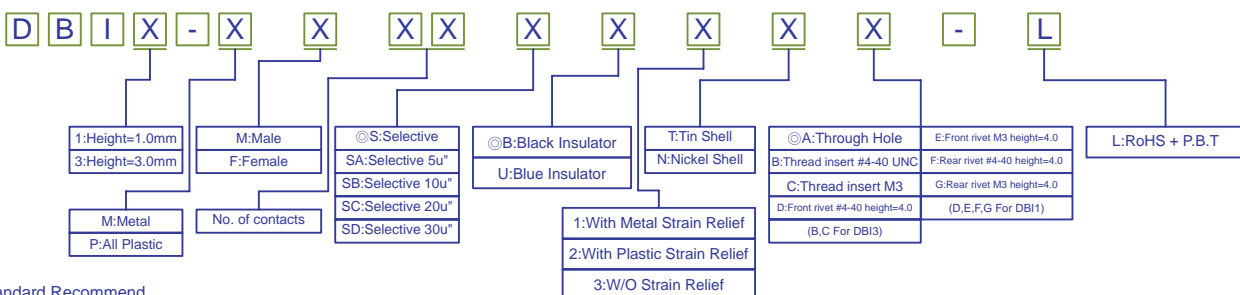

©:Standard Recommend

